

Product Data Sheet

SD 0301-2E06

July 2008

Damcos® BRCF 125

Hydraulic single-acting balanced rotary actuator 90° (Quarter-turn) fail-safe



Technical specification

Working pressure:	135 bar
Burst test:	675 bar
Total dry weight incl. mounting set (1.4 kg):	8.6 kg
Oil displacement:	0.026 l
Temperature range:	-20°C to +80°C
Rotation:	90°±1°
Hydraulic media and viscosities:	We recommend acid-free hydraulic oil. Viscosity range: 15-200 cSt. For recommended brands and for other media than oil please refer to separate data sheet.

DAMCOS®



EMERSON™
Process Management

Damcos® BRCF 125

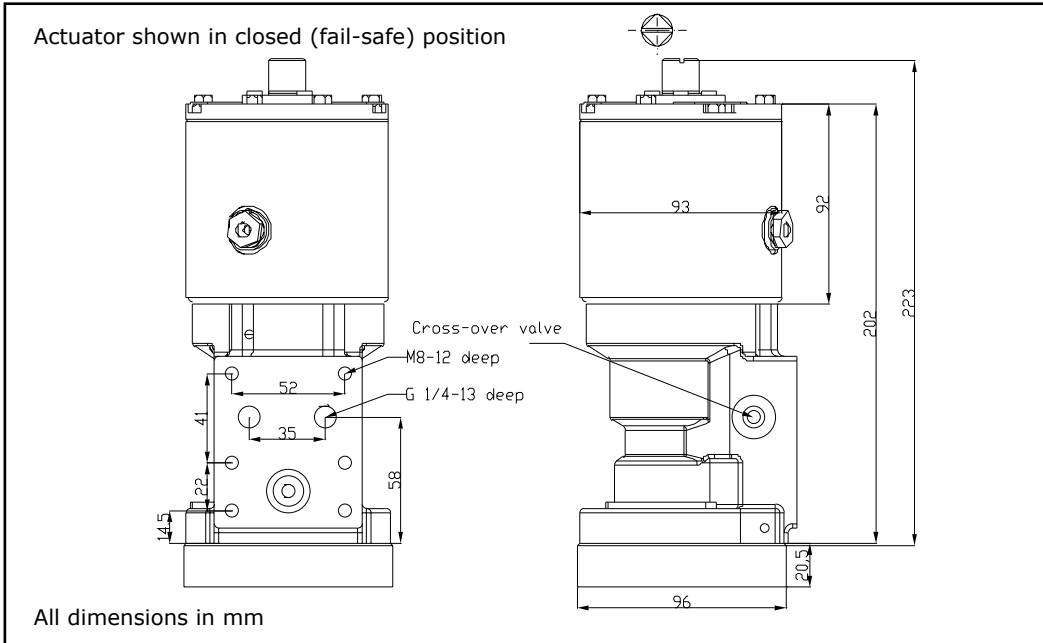
Main dimensions

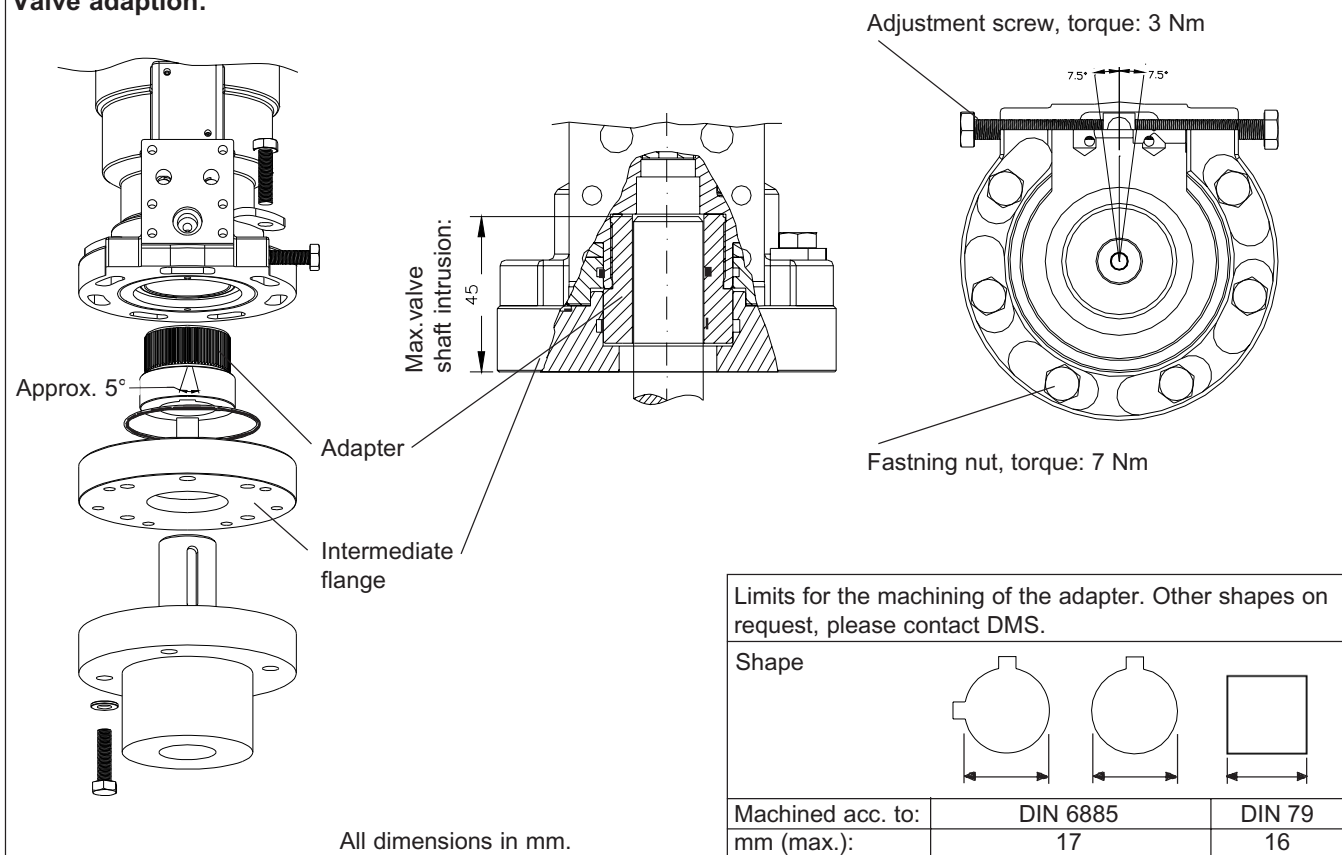

Valve adaption:



Damcos® BRCF 125

Performance

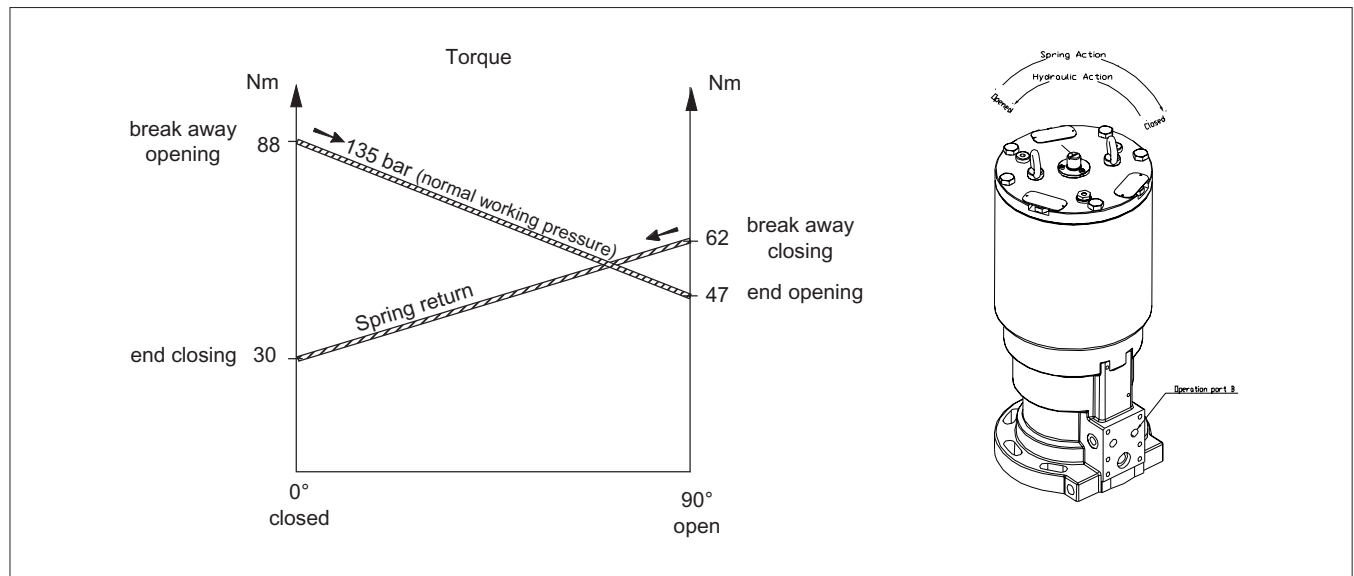

The Emerson logo is a trademark and service mark of Emerson Electric Co. Damcos and the Damcos logotype are registered trademarks of Damcos A/S. All rights reserved. The contents of this publication are presented for information purposes only, and while effort has been made to ensure their accuracy, they are not to be construed as warranties or guarantees, expressed or implied, regarding the products or services described herein or their use or applicability. All sales are governed by our terms and conditions, which are available upon request. We reserve the right to modify or improve the designs and specifications of our products at any time without notice. Damcos A/S accepts no responsibility for any errors that may appear in this publication.

This product is developed and managed by:
Emerson Process Management

Damcos A/S
 Aaderupvej 41
 DK-4700 Naestved
 T +45 5578 7200
 F +45 5578 7272

For global contacts:
www.EmersonProcess.com/marine